

Manifold Styles

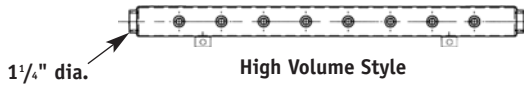

High Volume Style



Straight-Through Style

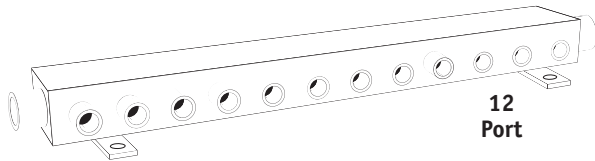
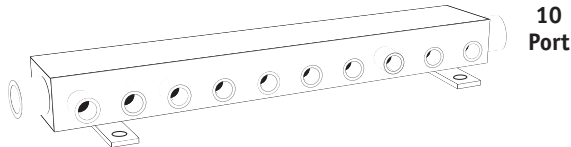
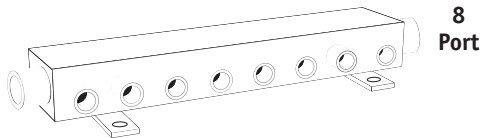
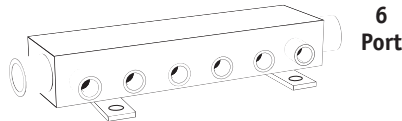
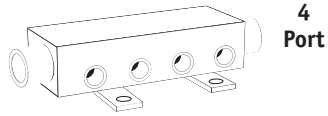

High Volume and Straight-Through Styles

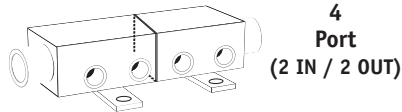

Split Bulkhead Style

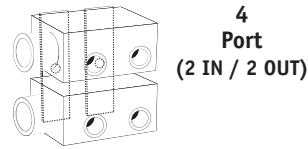
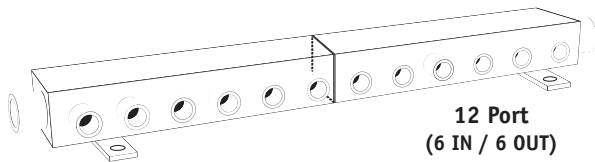
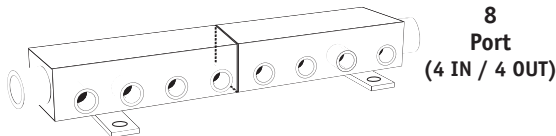

Stacked Style

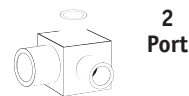
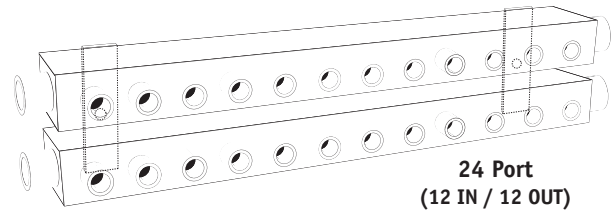
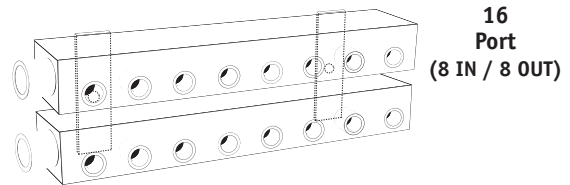
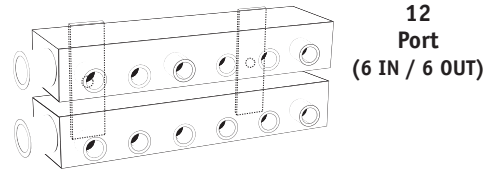

Double Outlet Style

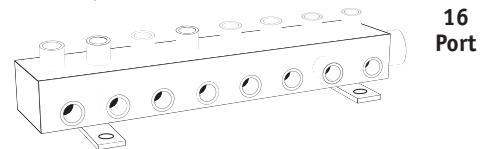
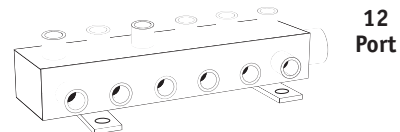
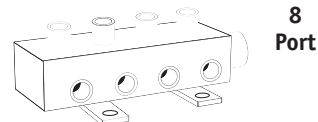

Custom Manifold Form

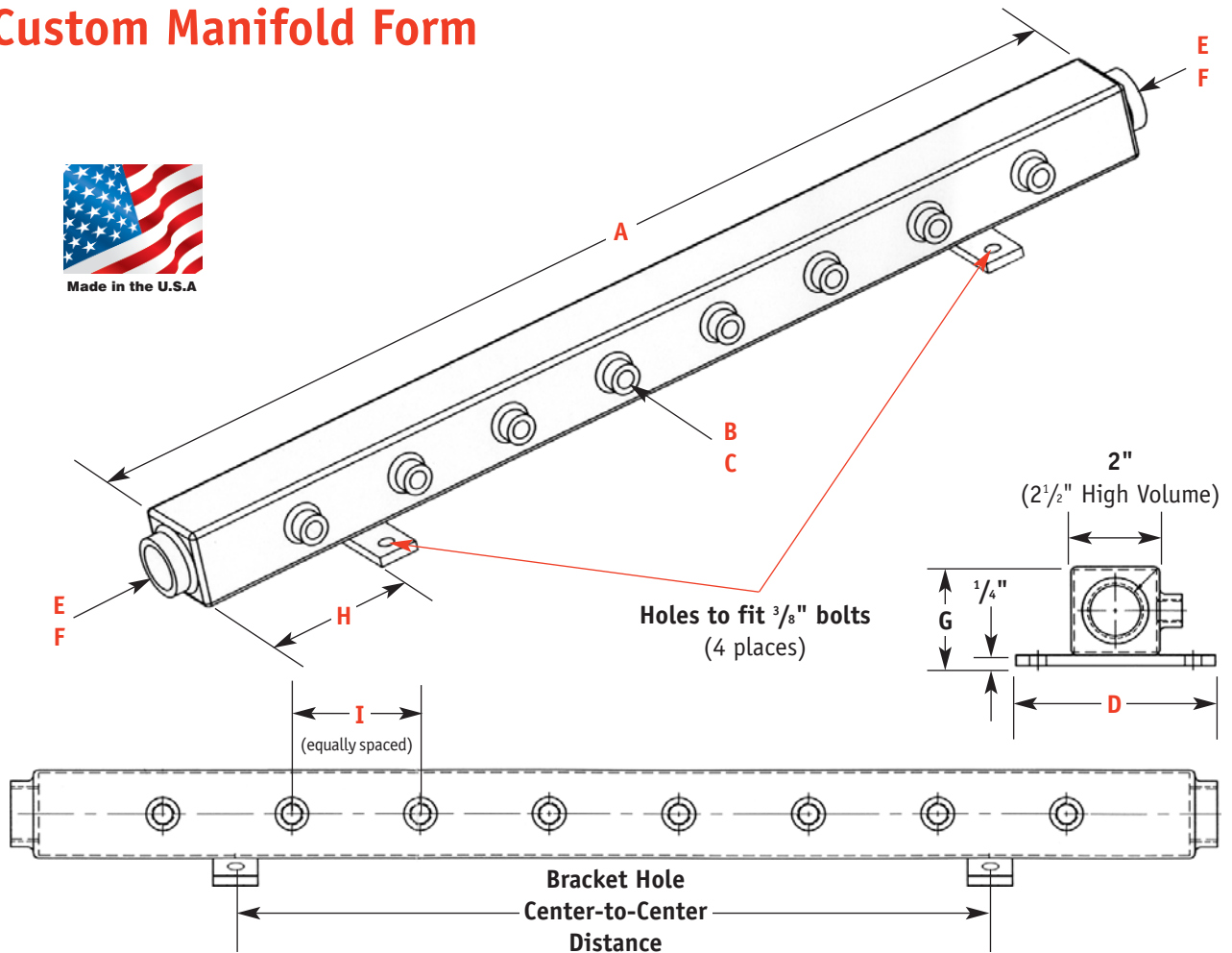

A) Overall Length: _____

B) Port Size (N.P.T.): _____ C) Number of Ports: _____

D) Width (includes mounting bracket): _____

E) Inlet/Outlet Size (N.P.T.): _____ F) Number of Inlet/Outlets: _____

G) Depth: _____ H) Mounting Bracket Distance: _____

I) Distance Between Ports (center-to-center): _____

J) Style: High Volume Straight-Through Split (Bulkhead) Stacked Double Outlet

K) Material: Painted Steel Stainless Steel

Date: _____ Quantity: _____ Phone: (_____) _____ Fax: (_____) _____

Name: _____ Title: _____

Company Name: _____ Email: _____

Address: _____

City: _____ State: _____ Zip: _____



www.imscompany.com | phone order toll-free (USA & Canada) **1.800.537.5375**

fax order toll-free (USA & Canada) 1.888.288.6900 | phone order toll-free (Mexico) 001.888.304.1307 | tech support toll-free (USA & Canada) 1.866.467.9001 | e-mail sales@imscompany.com

